



ELIT PLUS PLASTİK

2020



PLASTİK KALIP OTOMOTİV SAN. TİC. A.Ş.



HAKKIMIZDA

2018
Ocak

2018
Temmuz

2019
Ocak

2019
Ağustos

2019
Ekim

2019
Kasım

2018 Ocak ayında Bursa Hosab' da Tier-2 imalatçısı olmak amacıyla kurulmuştur.

V362 ve 560A projeleri devreye alındı.

290B projesi devreye alındı. Saplama montajı yapılan RCL ve TAIL gövdelerinin üretimine başlandı.

405B projesinin devreye alınmasıyla firmamıza montaj hattı kuruldu.

VW Touareg projesinin devreye alınmasıyla lüks araç kategorisinde üretim yapmaya başladık.

NEO 310 Projesi devreye alındı.

HAKKIMIZDA

Üst Yönetimden operasyonel kadroya kadar nitelikle otomotiv tecrübesine sahip ekibiyle birlikte yüksek teknolojik ekipmanları yapısına entegre ederek kaliteli ürün ve hizmeti müşterilerimize sunmaktayız. Başta otomotiv sektörü olmak üzere tüm alanlara hitap ederek, estetik ve çok komponentli plastik parçalar üretmekteyiz.

Plastik mühendislikleri kullanımıyla iç lens, bezel, gövde dış kapak, iç ve dış kapak, iç ve dış trim parçalarının imalat ve montajını yapmaktayız. Müşterilerimize istekleri doğrultusunda ihtiyacı olan doğru çözümü uygun maliyetle sunuyoruz. Sizlerle beraber gelişerek büyümeye devam ediyoruz.

KALİTE POLİTİKASI

Şirket politikamız doğrultusunda, kalitede mükemmelliğe ulaşmak ve devamlılığı sağlamak,
Çalışanların katılımıyla, teknolojik yenilikleri müşteri isteklerine uyarlamak ve memnuniyeti arttırmak,
Daima en iyi performansı gösterme çabası içerisinde yasalara uygun hareket ederek, sürekli iyileştirme ve değişime hızlı ayak uydurabilmeyi hedeflemek,

Enerjinin en verimli şekilde kullanılması amacıyla yenilenebilir enerji kaynaklarının önemini vurgulamak ve teşvikinde bulunmak hedefimiz arasındadır.
İş sağlığı ve güvenliği ile çevre bilinci hususlarında taviz vermeden tüm sistemle bütünleşik bir yapıda, insani koşulları en üst düzeyde sağlayıp örnek bir kuruluş olmaktadır.

VİZYON- MİSYON

- Çalışanların katılımıyla yüksek üretim kalitesi sağlayarak, pazar payını arttırıp aydınlatma sektörünün en iyi Tear-2 imalatçısı olarak müşterilerine yalnızca hatalı parça göndermemeyi değil aynı zamanda hatalı parça üretmemeyi hedeflemek.
- Butik üretim ilkesiyle müşterilerine çözüm ortağı olarak müşterilerinin bulunduğu lokasyonlarda üretim faaliyetleri, montaj ile nihai ürün yapmakla birlikte 2K ve 3K kalıp imalatına yüksek ürün hizmet kalitesinden ödün vermeden yer vermektedir.

- Müşterilerin beklentisi ve ihtiyaçlarının paralelinde güvenilir ve verimli biçimde üstün hizmet sunmaktır.
- Rekabet üstünlüğü sağlayacak çalışan eğitimleri ve teknolojiyle uyum içerisinde sürekli gelişim ve iyileştirme gerçekleştirmek.
- Otomotiv aydınlatma başta olmak üzere sektöre, ekonomik maliyet ve yüksek kalite standardı sağlayan plastik ürünler temin etmek.

HEDEFLERİMİZ

✓ Sektörün önde gelen Tear-2 imalatçısı olmak,

✓ Butik fabrika ilkesiyle müşterilerinin bulunduğu lokasyonlarda üretim faaliyetleri gerçekleştirmek,(2020 yılında Gebze lokasyonunda 2. işletmemize kurmak)

✓ En yüksek seviyede ürün kalitesi ve hizmet sunmak,

✓ Sürekli iyileştirme ve geliştirme,

✓ Hatalı parça göndermemek değil ÜRETMEK,

✓ Yeşil enerji kullanımını ve yaygınlaştırılmasını sağlamak.

ORGANİZASYON ve BELGELENDİRME

- ✓ Kuruluş Yılı: 2017
- ✓ Genel Merkez:
Hasanağa Organize
Sanayi Bölgesi/Bursa
- ✓ Personel Sayısı: 29
Mavi Yaka / 14 Beyaz
Yaka
- ✓ Sektör: Otomotiv
- ✓ Sertifikasyon: 16949
IATF 2019
- ✓ Toplam Alan: 1500 m²

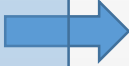

To related bodies;

Subject : Status of IATF 16949 certification process.

Date: 06.01.2020

Elit Plus Plastik Kalıp Otomotiv company with IRQS file number E/6011/IATF stage 1 audit finished successfully for certification IATF 16949:2016 . Also Stage 2 audit completed successfully at 29.12.2019 . **Result of stage 2 audit ; 6 minor non-conformity**. All of minor nonconformity will be verified offsite in 90 days . After these 6 minor NC verified (confirm effectiveness of corrective actions) by lead auditor then next step is Veto person check this NC verifications again and certification committee decision step and then issue certificate is final step .
This letter for your informing only .

IRQS LEAD AUDITOR

Uğur EKİCİ

ADP number : 5-ADP-12-06-1984

Mobile : 0506 345 2434

ugurekici@kascert.com

IATF 16949 GEÇİCİ
ONAY BELGEMİZ

ORGANİZASYON ŞEMASI

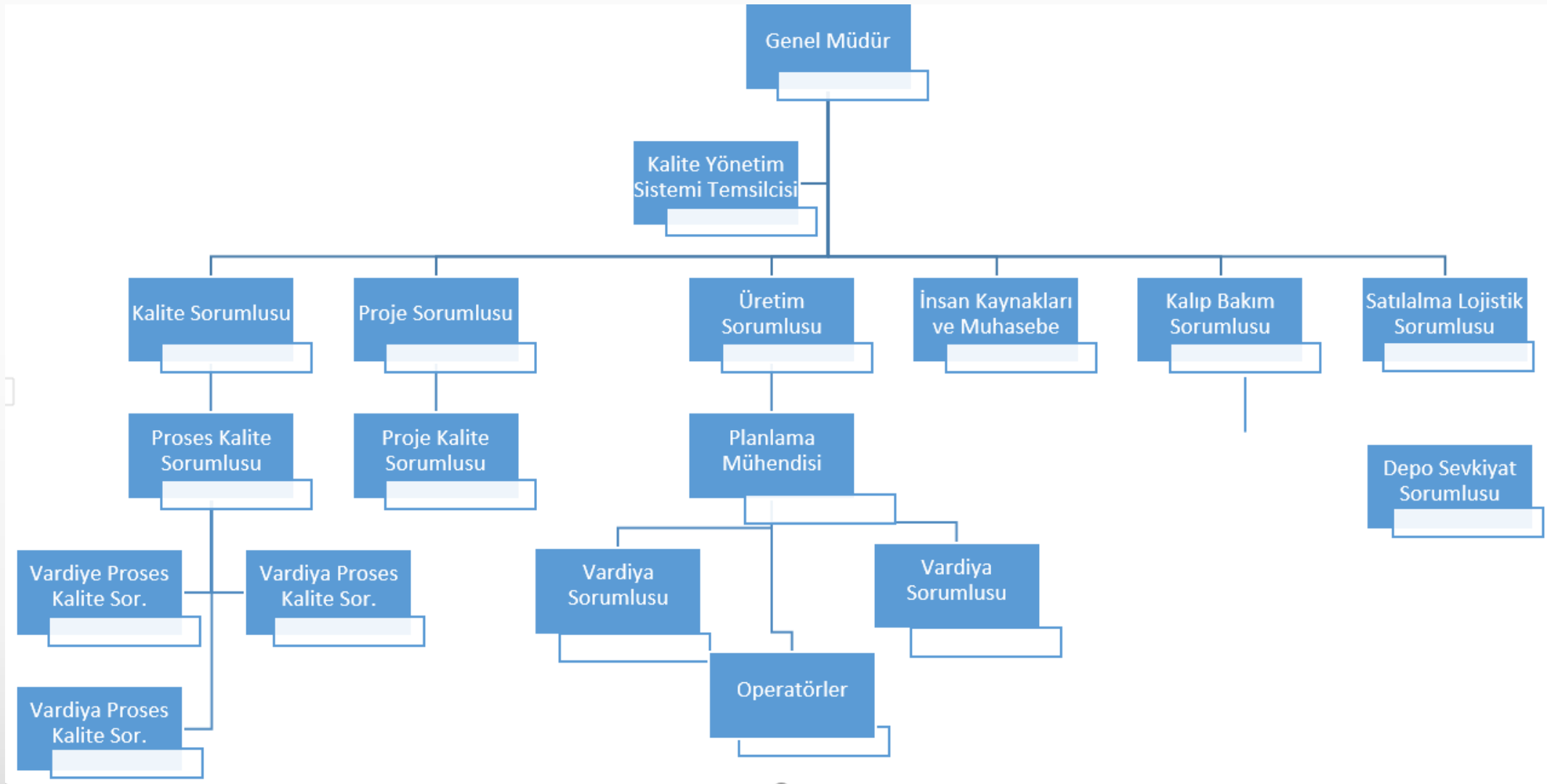

KALİTE SİSTEM ÇALIŞMALARI

VDA Standartlarını kalite sistemine entegre etmek için alınan eğitimler:

- ✓ VDA Olgunluk Seviye Güvencesi
- ✓ VDA2 PPA PPF Proje Yönetimi, Üretim Süreci Onayı, Fizibilite Değerlendirmesi-Operasyonel Planlama
- ✓ VDA 6.3 Ürün Süreç Denetçisi
- ✓ VDA 4 Genel Risk Analizleri ve FTA ve FMEA
- ✓ VDA PSR - PSB (Ürün Bütünlüğü Ürün

Güvenliği Temsilcisi)

Audit Result					
Project, Product, Process	RED	YELLOW	GREEN	n.a.	Rating
Injection and Assembly	0	10	26	0	YELLOW
	0	0	0	0	
	0	0	0	0	

Remarks	
RED	Barred supplier: Nomination is not possible:
YELLOW	Conditionally approved: Nomination is conditionally possible:
GREEN	Fully approved supplier: Nomination is possible:

5 Mart 2019 tarihinde
ODELO tarafından
yapılan VDA denetimi
sonucumuz

GÜÇLÜ YANLARIMIZ

- ✓ Kurucu ortakların yeteneklerinin hem kalıp hem de enjeksiyon alanlarında birleştirilmesi
- ✓ Elit Makine ile işbirliğinde kalıp geliştirmeye hızlı çözümler sunmak
- ✓ Makine ekipmanlarının üretim ihtiyaçlarına uygunluğu,
- ✓ Deneyimli kalıp bakım ekibi sayesinde kalıp ve devreye alma transfer projeleri ile ilgili sorunların üstesinden başarıyla gelinmesi
- ✓ Müşterinin bulunduğu yere yakınlık,
- ✓ Değişim ve yeniliklere hızlı adaptasyon,
- ✓ Çözüm odaklı yaklaşım.





MAKİNA PARKURU

SIRA NO	MAKİNE NO	MAKİNE ADI	MAKİNE RESMİ	KİLİTLEME TONAJI	MOTOR GÜCÜ	VİDA TİPİ	TEORİK ENJ. HACMİ (cm ³)	VİDA ÇAPLARI	KOLON ARASI (mm) HxV	MİN. MAX KLP.KAL.	SABİT PLAKA FLANŞ ÇAPI(m m)	HAREKETLİ PLAKA FLANŞ ÇAPI.(mm)
1	EN 40	NEGRI BOSSI		40 TON		UNIVERSAL		28 mm	255*255	420		
2	EN 125-1	ENGEL		125 TON	22 KW	UNIVERSAL	192	40 mm	740*520	180-600	125	125
3	EN 125-2	ENGEL		125 TON	22 KW	UNIVERSAL	192	40 mm	740*520	180-600	125	125
4	EN 130	NEGRI BOSSI		130 TON	22 KW	UNIVERSAL		45mm	410x410	220-600	125	125



MAKİNA PARKURU

SIRA NO	MAKİNE NO	MAKİNE ADI	MAKİNE RESMİ	KİLİTLEME TONAJI	MOTOR GÜCÜ	VİDA TİPİ	TEORİK ENJ. HACMİ (cm ³)	VİDA ÇAPLARI	KOLON ARASI (mm) HxV	MİN. MAX KLP.KAL.	SABİT PLAKA FLANŞ ÇAPI(m m)	HAREKETLİ PLAKA FLANŞ ÇAPI.(mm)
5	EN 200	DEMAG ERGOTECH		200 TON	22 KW	UNIVERSAL	763	60 mm	560*560	660-310	160	160
6	EN 500	NEGRI BOSSI		500 TON	45 KW	PMMA	880	60 mm	930*800	500-1050		
7	EN 550	KRAUSS MAFFEI		550 TON	125 KW	PMMA	1232	70-55 mm	1040*910	400-950		
8	EN 650	NEGRI BOSSI		650 TON	60 KW	PC ABS	2060	80 mm	1010*860	500-1100	200	200

MAKİNA PARKURU

SIRA NO	MAKİNE NO	MAKİNE ADI	MAKİNE RESMİ	KİLİTLEME TONAJI	MOTOR GÜCÜ	VİDA TİPİ	TEORİK ENJ. HACMİ (cm ³)	VİDA ÇAPLARI	KOLON ARASI (mm) HxV	MİN. MAX. KLP.KAL.	SABİT PLAKA FLANŞ ÇAPI(m m)	HAREKETLİ PLAKA FLANŞ ÇAPI.(mm)
9	EN 800	NEGRI BOSSI		800 TON	60 KW	PC ABS	2600	90 mm	1100*950	500-1200	200	200
10	EN350	KRAUSS MAFFEI		350 TON		UNIVERSAL		70 mm	800*710	380-1300		
11	EN320	KRAUSS MAFFEI		320 TON		PC ABS		50 mm	710*710	580-1300		
12	EN 160	KRAUSS MAFFEI		160 TON		PC		40 mm	520*520	650.		

MAKİNA PARKURU

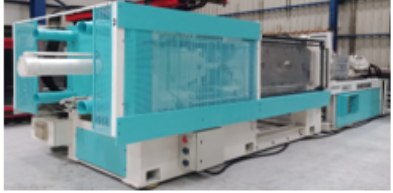
SIRA NO	MAKİNE NO	MAKİNE ADI	MAKİNE RESMİ	KİLİTLEME TONAJI	MOTOR GÜCÜ	VİDA TİPİ	TEORİK ENJ. HACMİ (cm ³)	VİDA ÇAPLARI	KOLON ARASI (mm) HxV	MIN. MAX KLP.KAL.	SABİT PLAKA FLANŞ ÇAPI(m m)	HAREKETLİ PLAKA FLANŞ ÇAPI.(mm)
13	EN500	DEMAG ERGOTECH		500 TON		UNIVERSAL			810*800			
14	EN650	KRAUSS MAFFEI		650 TON		UNIVERSAL			980*930			
15	EN 500 2K	DEMAG ERGOTECH 500 T 2K DÖNER TABLA		500 TON			ABS (1,05) PA+GF(1,2)		810*800			

HİZMETLERİMİZ

ÇOK KOMPONENTLİ PLASTİK
PARÇALAR

AYDINLATMA PARÇALARI

Elastik Parça Üretimi
Ağırlıklı Olmak Üzere;

AYNA PARÇALARI

İÇ TRİM

İŞLETME YERLEŞİM PLANI

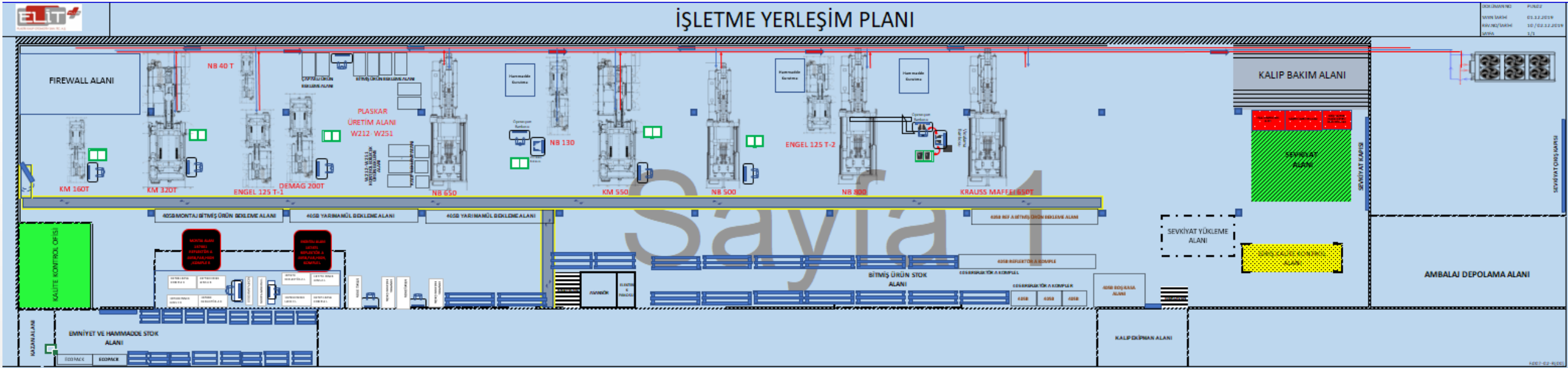

TEST VE ÖLÇÜM CİHAZLARIMIZ

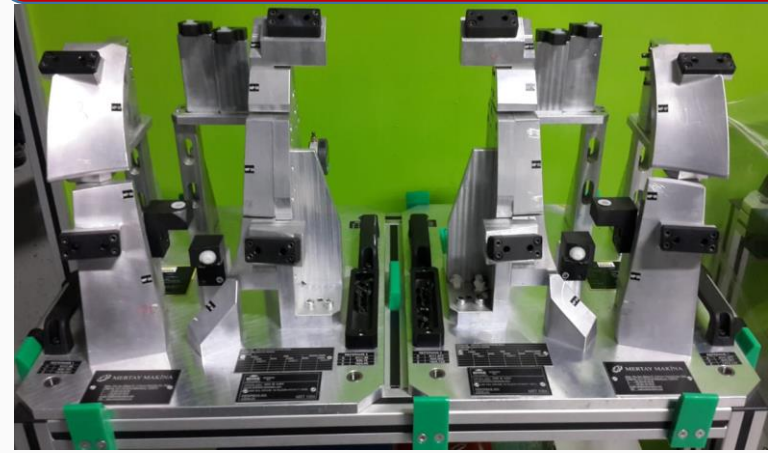

1D ÖLÇÜM CİHAZI

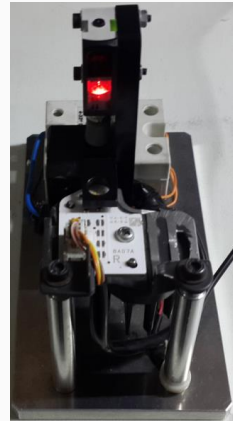

LIGHT GUIDE
YAKMA TEST
CİHAZI



LUKS METRE



SENTİL ÇAKISI

2019 2. YARISI DEVREYE ALINDI.



AKIŞKANLIK TEST CİHAZI



1D ÖLÇÜM CİHAZI



KUMPAS



PİM MASTAR SETİ

**2020 YILININ 2. YARISI CMM CİHAZI YATIRIMIMIZ OLUCAK
TEST CİHAZ YATIRIMLARIMIZ DEVAM ETMEKTEDİR.**

ELİT MÜŞTERİLERİMİZ İÇİN

SERİ
ÜRETİM

560A TOYOTA CHR

SERİ
ÜRETİM



BASE C R



BASE C L



BASE D L



BASE D R

Hammadde : PC SİYAH



560 BASE D ARAÇ POZİSYONU



MONTAJ BANKOSU L

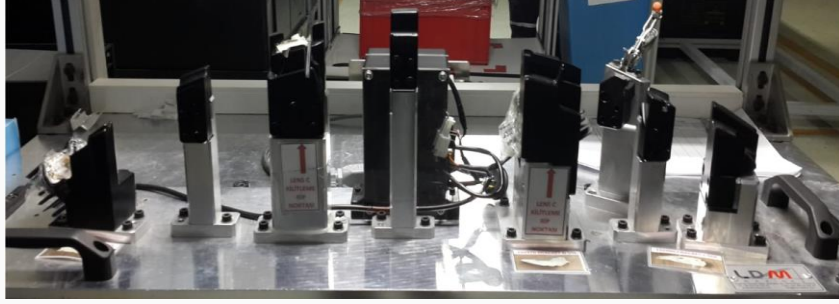

MONTAJ BANKOSU

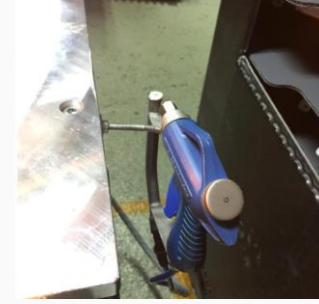

DEİYONİZE HAVA SİSTEMİ

MONTAJ BANKOSU R

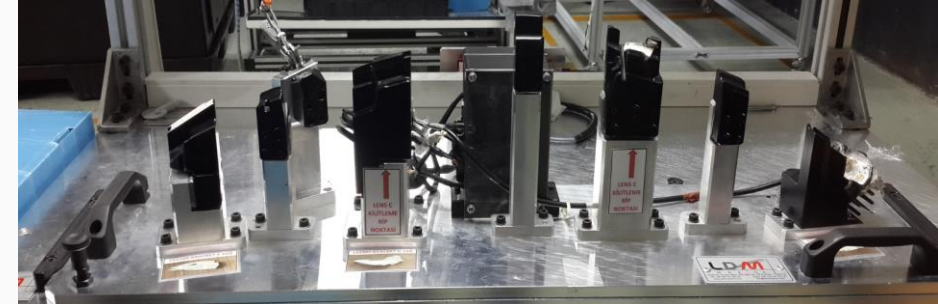

REFLEKTÖR A



+

INNER LENS C

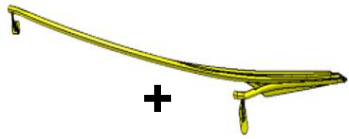

+

BRAKET C/D/E

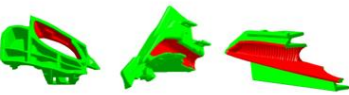

+

INNER LENS A



REFLEKTÖR A KOMPLE



REFLEKTÖR A KOMPLE

REFLEKTÖR A

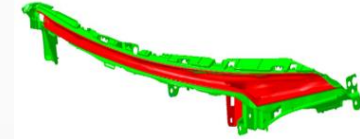

+

INNER LENS C

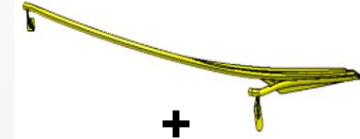

+

BRAKET C/D/E

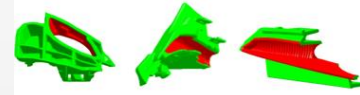

+

INNER LENS A

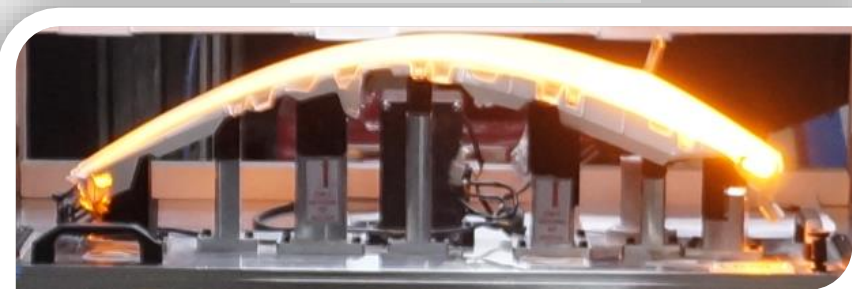

TOYOTA 405B PROJESİ INNER LENS C



INNER LENS C (LIGHT GUIDE 95 cm)



NEM ALMALI KURUTUCU SİSTEMİ



LIGHT GUIDE PARÇA İÇİN ÖZEL AZOT SİSTEMİMİZ

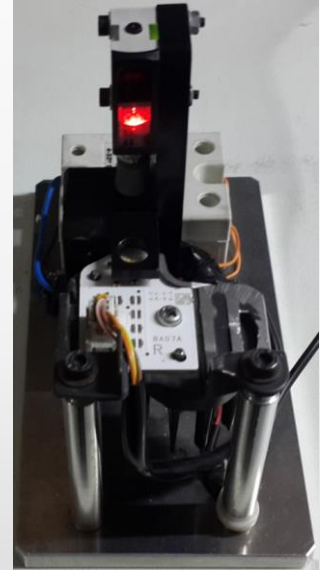

LIGHT GUIDE YAKMA TEST CİHAZI



SICAK MAKAS VE ROBOT ELİ
YOLLUK KESME SİSTEMİMİZ
Hammadde : PC TARFLON LC 1500 (IDEMITSU)

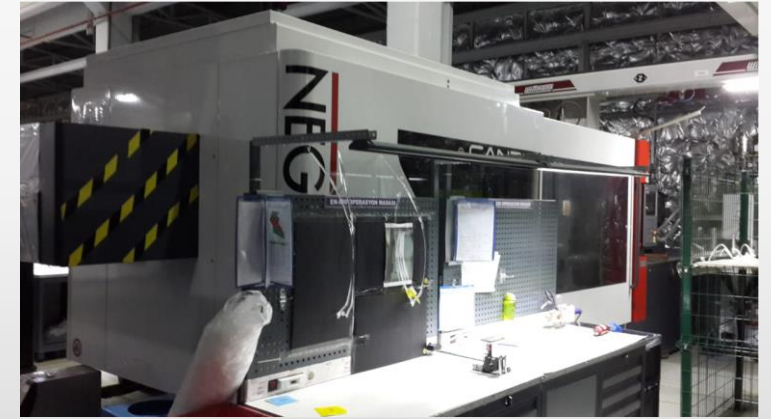

NEGRI BOSSI 500T LIGHT GUIDE
ÖZEL MAKİNEMİZ

TOYOTA 405B PROJESİ INNER LENS A



INNER LENS A R



INNER LENS A L



DEİYONİZE HAVA SİSTEMİ

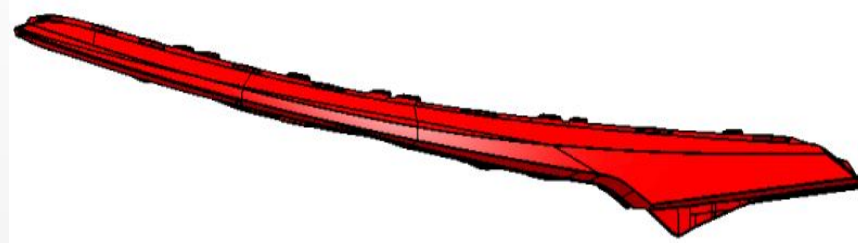

KUMLU GÖRÜNÜR YÜZEY



Hammadde : PC ŞEFFAF



TOYOTA 405B PROJESİ REFLEKTÖR A



REFLEKTÖR A R



REFLEKTÖR A L

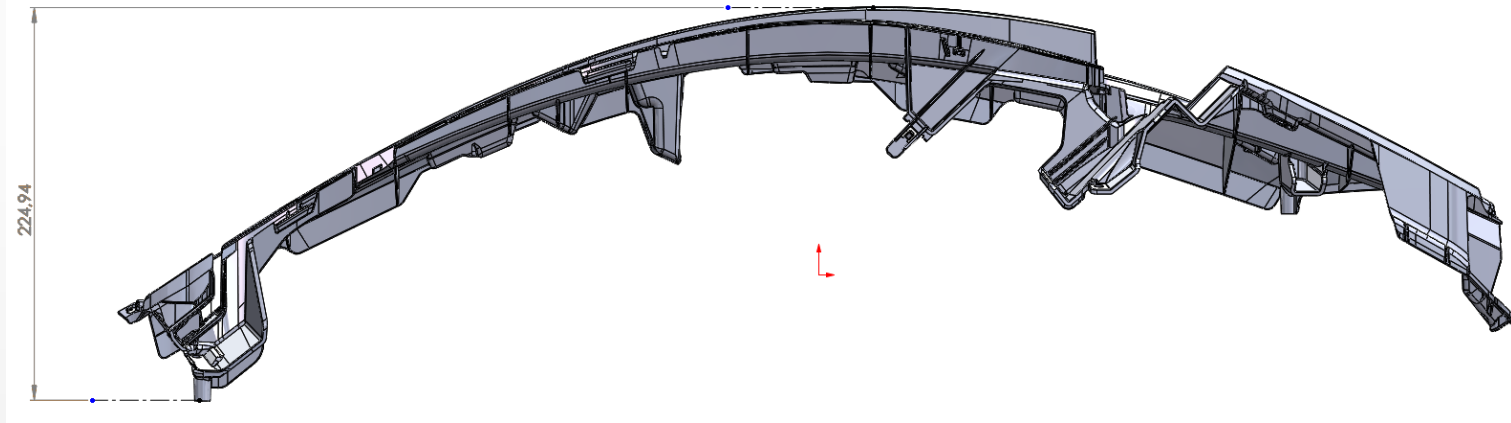

HAMMADDE PC BEYAZ



TOYOTA 405B PROJESİ BRAKET C/D/E



BRAKET C/D/E

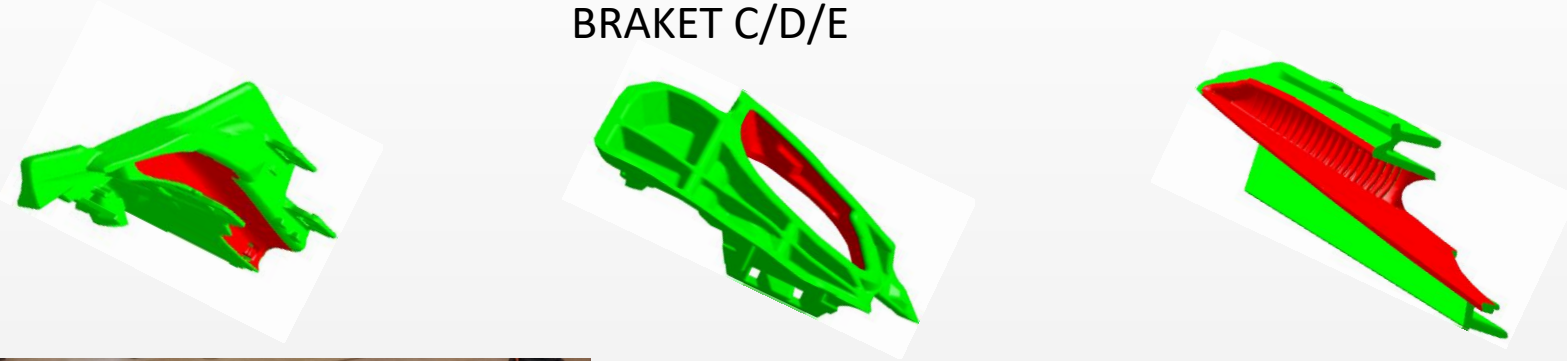

HAMMADDE PC BEYAZ



TOYOTA 405B PROJESİ FIRE WALL ALANI

405B REFLEKTÖR A KOMPLE L

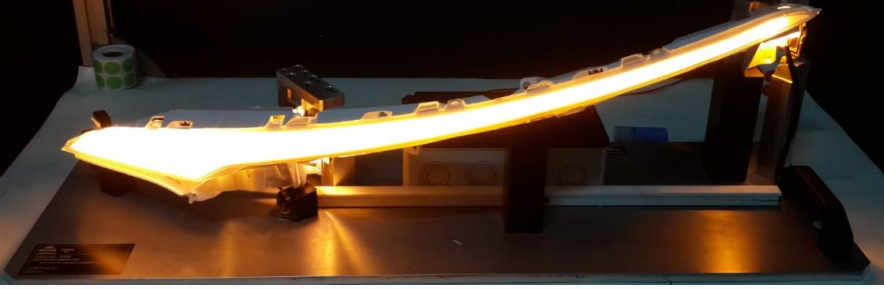

405B REFLEKTÖR A KOMPLE R

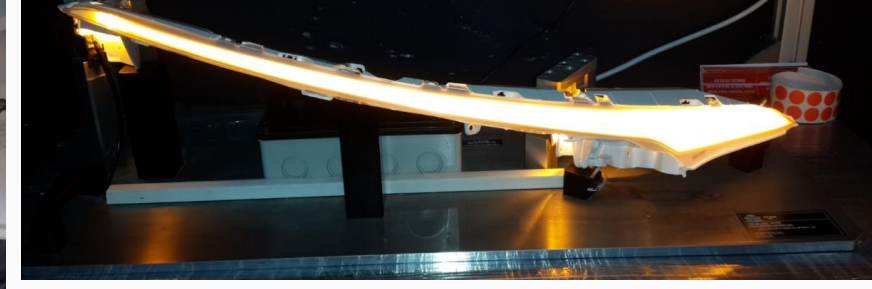

405B PROJESİ FIREWALL ALANI

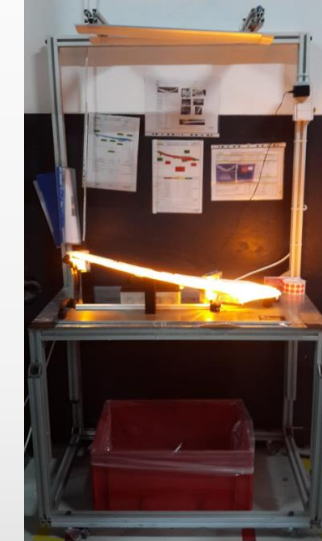

ÜRÜNLERİMİZİ KALİTE DUVARINDAN GEÇİRDİKTEN SONRA MÜŞTERİLERİMİZE SEVKİYATINI GERÇEKLEŞTİRİYORUZ.



405B PROJESİ PES COVER R/L

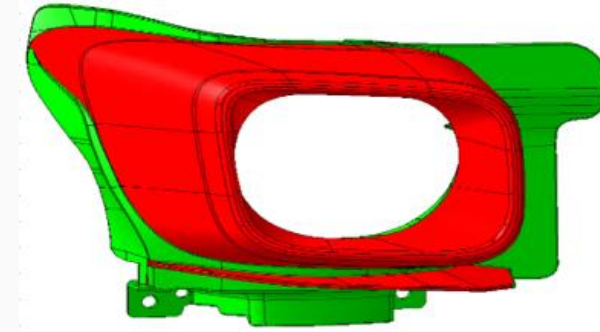

405B PROJESİ PES COVER GÖRÜNÜR PARÇA



405B PROJESİ PES COVER ARAÇ POZİSYONU



HAMMADDE : DUPONT PBT SİYAH



Firmamızda, proje bazlı montaj işlemleri gerçekleştirilmektedir. Montaj operasyonunda, poke yoke ve sensör uygulamalarına sahip montaj bankosu kullanılmaktadır.

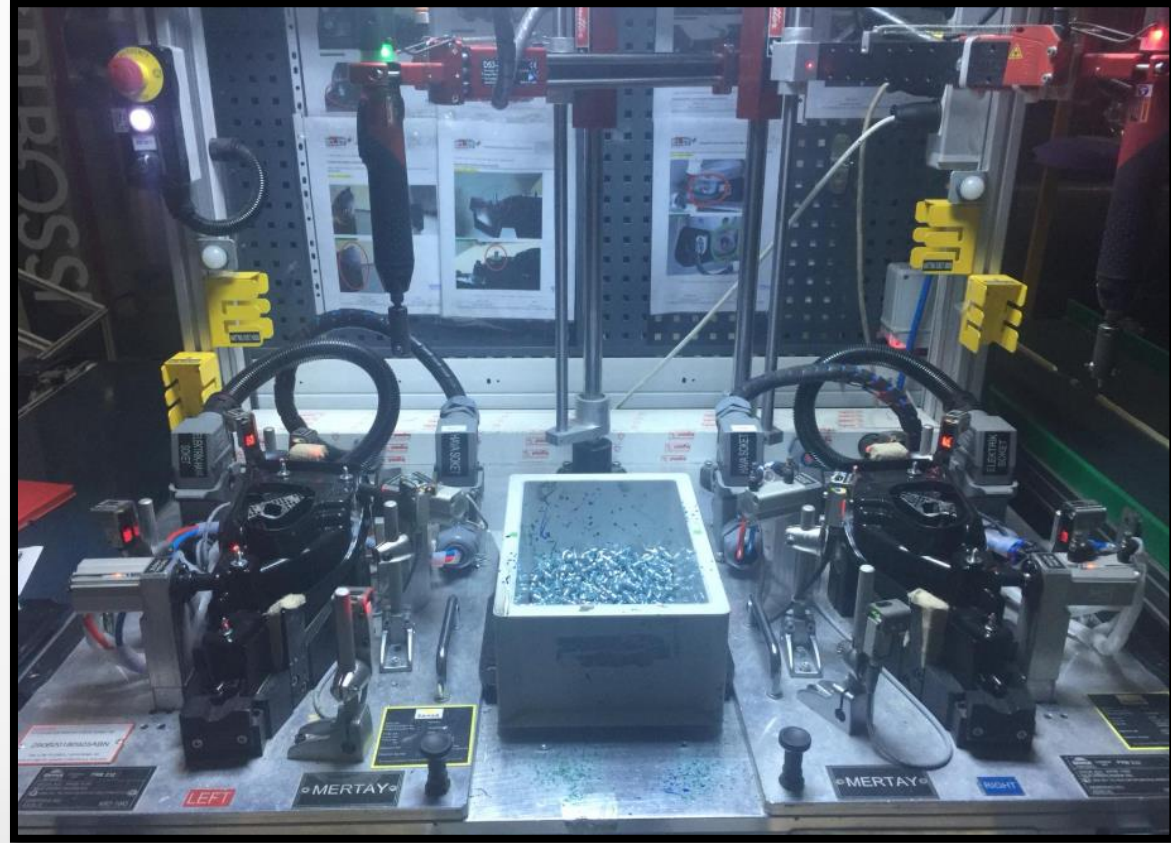

290B TAIL PROJESİ VİDALAMA BANKOSU

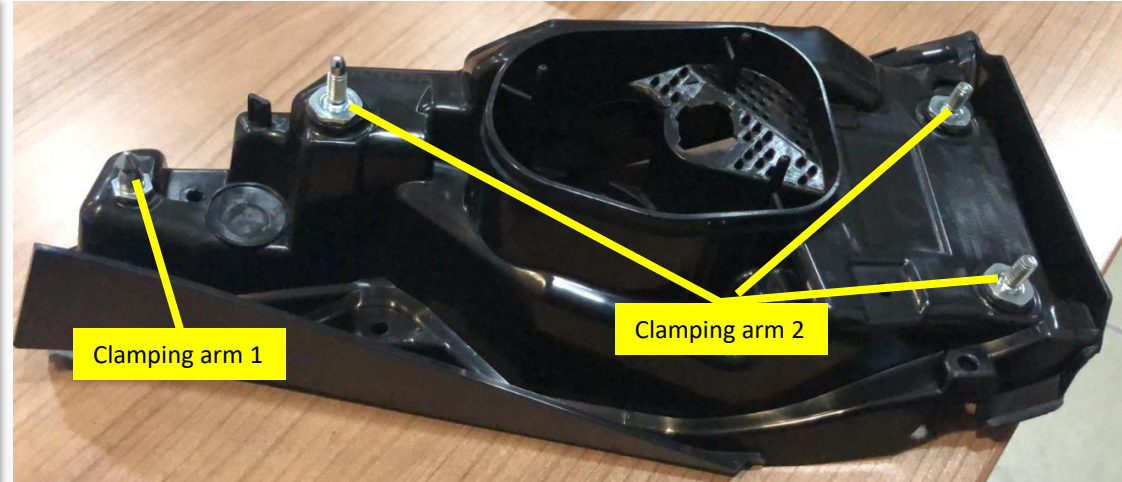

290B TAIL R

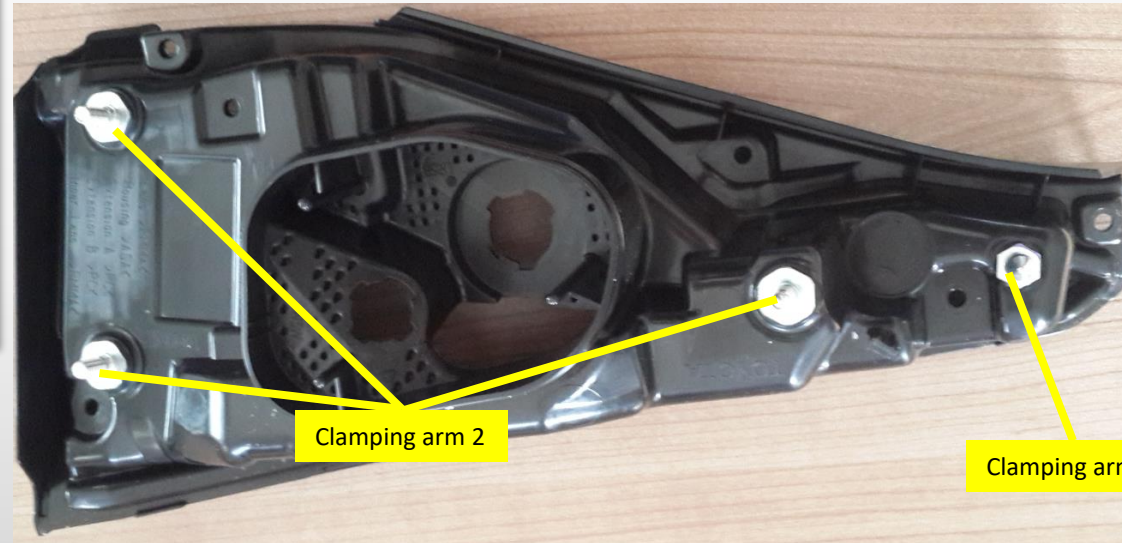

290B TAIL L

TOYOTA 290B TAIL BV/HV HOUSING

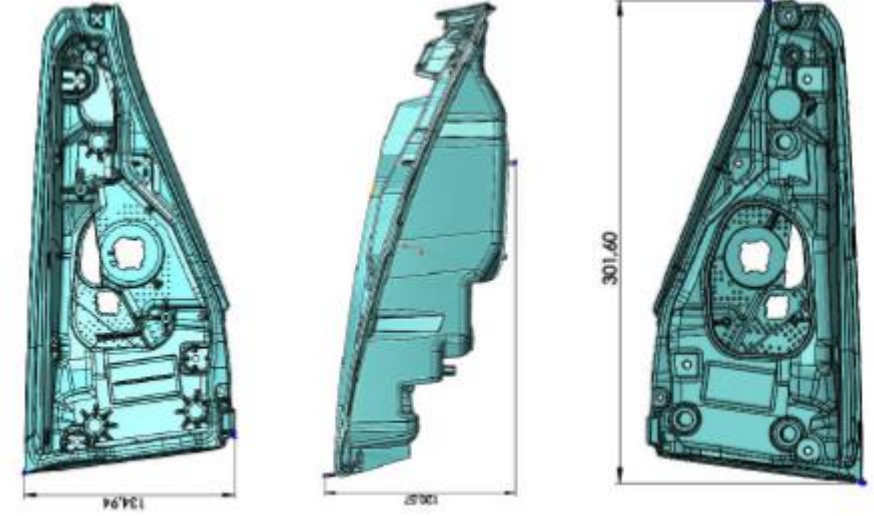
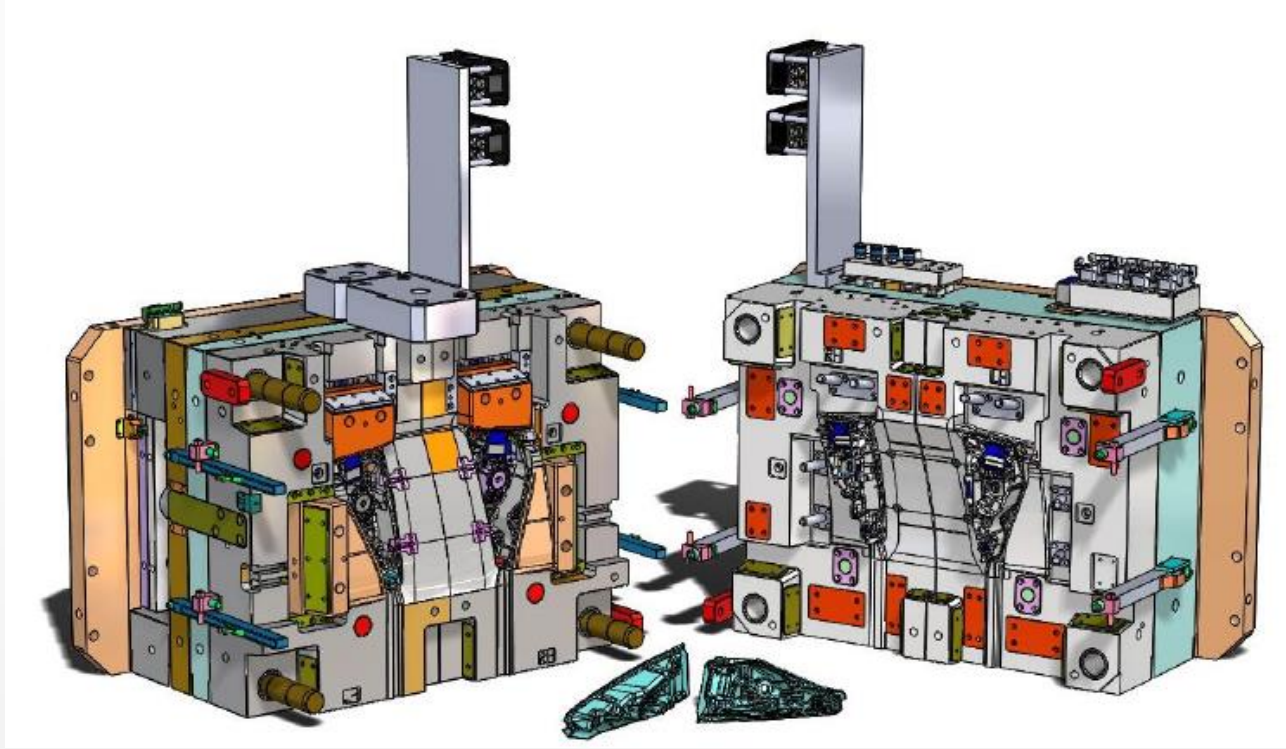

KALIBIN ÜRETİMİ KALIP FİRMAMIZDA YAPILMIŞTIR.

Hammadde : ASA BLACK



Firmamızda, proje bazlı montaj işlemi gerçekleştirilmektedir. Montaj operasyonunda, poke yoke ve sensör uygulamalarına sahip montaj bankosu kullanılmaktadır.

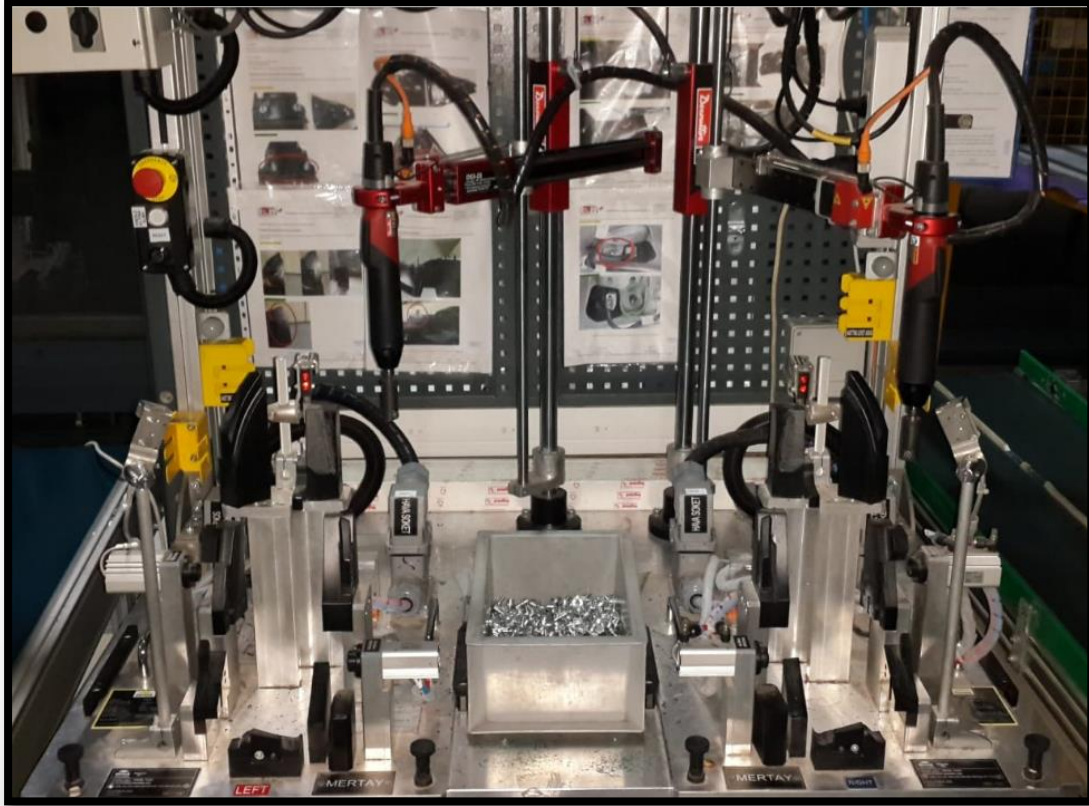

290B RCL PROJESİ VİDALAMA BANKOSU



290B RCL R



290B RCL L

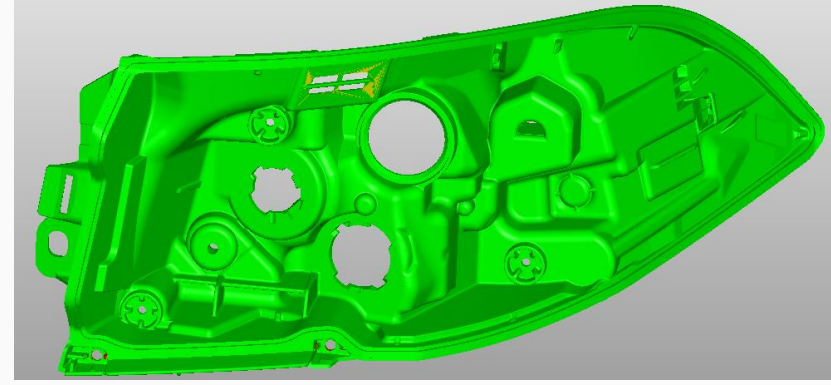
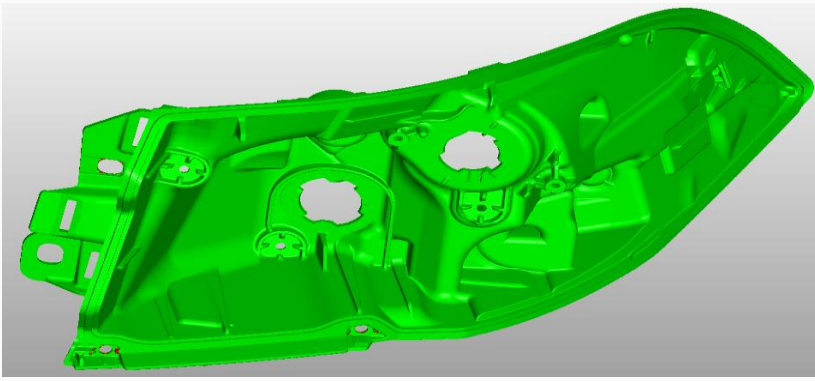

TOYOTA 290B RCL BV/HV GÖVDE



TOYOTA 290B RCL R/L GÖVDE

Hammadde : ASA BLACK



TOUREG ÇAMURLUK



TOUREG ÇAMURLUK L

TOUREG BAGAJ



TOUREG ÇAMURLUK R



TOUREG ÇAMURLUK ARAÇ POZİSYONU



LENS HAMMADDE : PMMA BUZLU ŞEFFAF



TOUREG BAGAJ L



TOUREG BAGAJ R



ARAÇ POZİSYONU



WV NEO LIGHT BAR CARRIER R



WV NEO LIGHT BAR CARRIER L



WV NEO LIGHT BAR CARR R/L

ELİT MÜŞTERİLERİMİZ İÇİN



Hammadde : PC



STOK ALANLARI

BİTMİŞ ÜRÜN DEPOSU



DİNAMİK RAF TANIMLARI



ERP KULLANIM ALANLARI

- ✓ Adresleme ve depo yerleşimi
- ✓ FIFO
- ✓ İzlenebilirlik
- ✓ Müşteri özel isteği doğrultusunda uyarlanabilen etiket tanımlamaları
- ✓ Sipariş ve sevkiyat doğrulama sistemi

YENİ SEVKİYAT DEPO ALANIMIZ

- 84 m² YENİ SEVKİYAT DEPO ALANI



REFERERANSLARIMIZ- ELİTPLUSPLASTİK



REFERERANSLARIMIZ-ELİT MAKİNE

ARaymond®
MORE THAN FASTENING

FARBA®
Otomotiv Aydınlatma
ve Plastik Fabrikaları A.Ş.

Gücsan
"power inside"

METALSAN
ENDÜSTRİYEL ÜRÜN. SAN. VE TİC. A.Ş.

odelo
Automotive Signal Lights

c.f.maier
COMPOSITES



FARPLAS



PLASKAR
Plastik Enj. Oto. Yed. Parça Tic. ve San. A.Ş.

DENSO

FEKA
AUTOMOTIVE

MAHLE
Driven by performance

plascam a.ş.

SERDAR PLASTİK

faurecia

FOMPAK
Automotive Plastics and Interiors

MECAPLAST
GROUP

takosan
AUTOMOTIV S.R.L.

MAKİNE PARKI / MACHINE PARK

TEL EREZYON TEZGAHLARI / WIRE EDM MACHINES	X	Y	Z	Tabla Yüklü Table Load
SODICK AQ 750 LH	750	500	600	2.000 kg
SODICK AQ 600 L	600	400	350	1.000 kg
SODICK AQ 325 L	350	250	250	300 kg



DALMA EREZYON TEZGAHLARI / SINK EDM MACHINES	X	Y	Z	Tabla Yüklü Table Load
OSCARMAX S3010 2H	3000	1000	1260	15.000 kg
OSCARMAX S1510 CNC CMAX	1500	1000	1260	11.000 kg
OSCARMAX S860 NC	800	600	600	4.000 kg
OSCARMAX S550 NC	500	400	350	1.350 kg
OSCARMAX S430 NC	400	300	300	550 kg

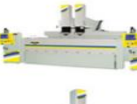

DERİN DELİK TEZGAHLARI / DEEP HOLE DRILLING MACHINES	Çap Diameter	Boy Length	Tabla Yüklü Table Load
MICRONTEC GD-2500 H/NC	Ø 3-32	1800	15.000 kg
MICRONTEC GD-1200 H/NC	Ø 3-32	1200	5.000 kg



TAŞLAMA TEZGAHLARI / GRINDING MACHINES	X	Y
PROTH PSGO 75150 AHR	850	1800
PROTH PSGC 60120 AHR	650	1330
PROTH PSGS 4080 AHR	400	800



15





8

MAKİNE PARKI / MACHINE PARK



5 EKSEN CNC MAKİNELER / 5 AXIS CNC MACHINES	X	Y	Z	RPM	Tabla Yüklü Table Load
DMG MORI DMU 90P DUOBLOCK	900	1050	850	20.000	1.800 kg
DMG MORI CMX 70U	750	600	520	12.000	350 kg
DMG MORI CMX 70U	750	600	520	12.000	350 kg
DMG MORI DMU 50 3RD GENERATION	650	520	475	15.000	300 kg
HERMLE C650	1050	900	600	18.000	1.500 kg

3 EKSEN CNC MAKİNELER / 3 AXIS CNC MACHINES	X	Y	Z	RPM	Tabla Yüklü Table Load
AWEA BL 3018 FM CNC BORWERK (5+2 AXIS)	3000	2000	1400	8.000	12.000 kg
AWEA LP 3021 KÖPRÜ TİPİ / BRIDGE TYPE	3000	2100	760	10.000	12.000 kg
AWEA SP 2014 KÖPRÜ TİPİ / BRIDGE TYPE	2100	1600	1200	6.000	8.000 kg
AWEA VP 2012 KÖPRÜ TİPİ / BRIDGE TYPE	2000	1200	760	10.000	4.000 kg
AWEA VP 2012 KÖPRÜ TİPİ / BRIDGE TYPE	2000	1200	760	10.000	4.000 kg
AWEA VP 2012 KÖPRÜ TİPİ / BRIDGE TYPE	2000	1200	760	10.000	4.000 kg
YCM NXV 1680 A	1400	800	800	12.000	2.000 kg
AWEA AF 1250	1250	620	620	12.000	1.000 kg
MAXMILL HQM 1260	1200	650	630	12.000	1.000 kg
MAXMILL QMC 600	610	410	530	12.000	500 kg

CNC TORNA TEZGAHI / CNC TURNING MACHINE	Çevirme Çapı Rotation Diameter	Tornalama Çapı Turning Diameter	Tornalama Boyu Turning Height
LITZ EF-108 CNC TORNA	400 mm	320 mm	530 mm

14





MAKİNA ve KALIP ELEMANLARI SAN. TİC. LTD. ŞTİ.

ELİT MAKİNA ve KALIP ELEMANLARI SAN. TİC. LTD. ŞTİ.
Şekerpınar Mah., Marmara Geri Dönüşümcüler Sanayi Sitesi
Marmara Caddesi No: 8 Çayırözü / Kocaeli / TURKEY

Tel : +90 262 658 24 68 Fax : +90 262 658 24 70

info@elitmakina.com.tr

BİZE ULAŞIN

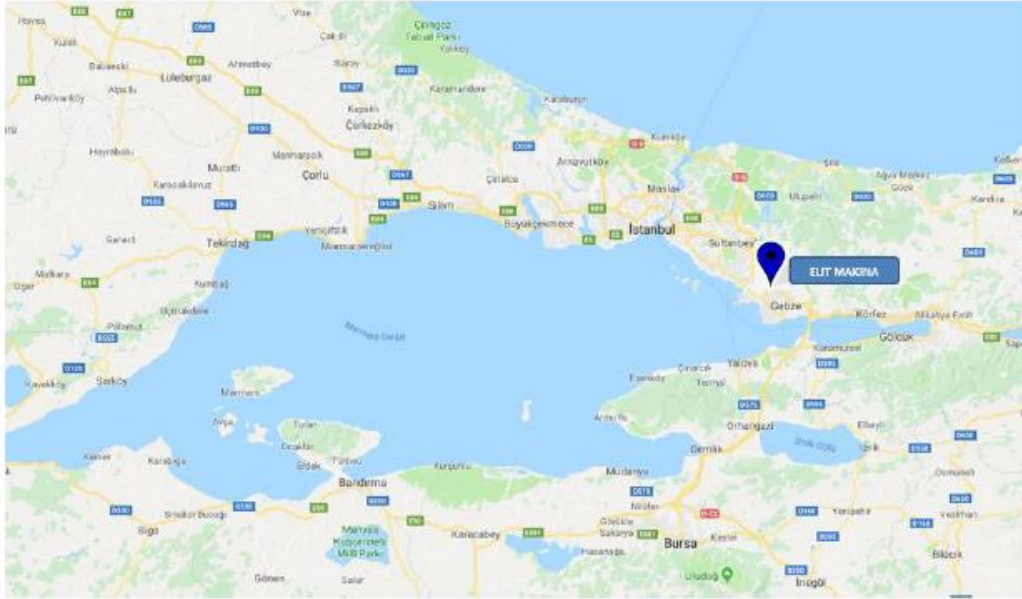

ELİT MAKİNE

Adres : Marmara Geri Dönüşümcüler Sanayi Sitesi
Marmara Caddesi No:8 Çayirova/ KOCAELİ
Tel : 0090 262 658 2468-69
Fax : 0090 262 658 2470
Web : www.elitmakina.com.tr

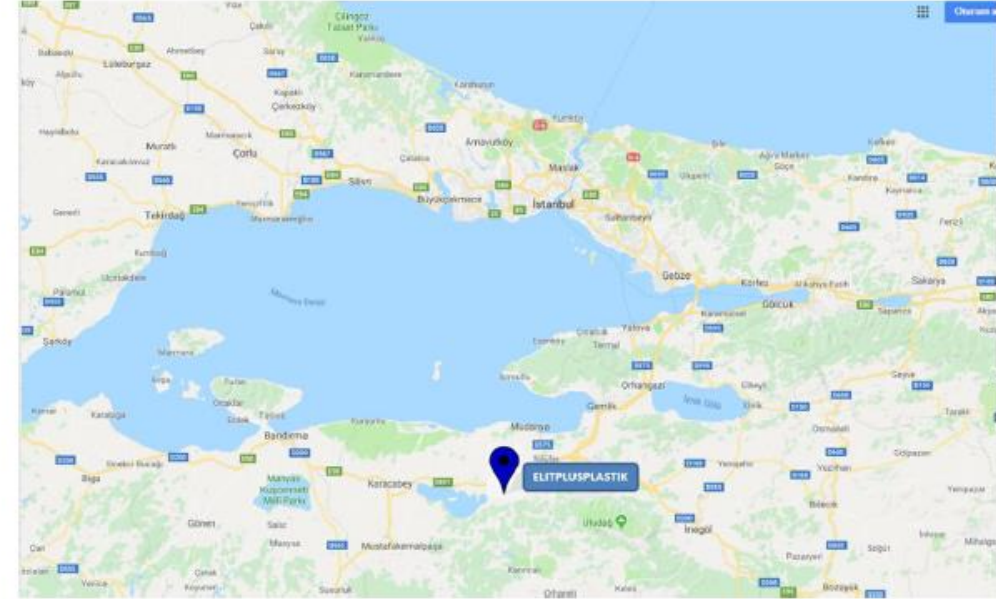

ELİTPLUS PLASTİK

Adres : Hasanağa OSB Hosab Sanayi Cad.
No:42 Nilüfer/ BURSA
Tel : 0090 224 484 2040
Fax : 0090 224 484 2041
Web : www.elitplusplastik.com

ELİT MÜŞTERİLERİMİZ İÇİN
ELİT MÜŞTERİLERİMİZ İÇİN
ELİT TEDARİKÇİNİZ ELİT PLUS